



Dishwashing

Reliable, Easy and Safe

green&clean Glasswashers
and Undercounter Dishwashers



You talk...

I'd like to have a dishwasher with an appealing look&feel, less water consumption and which offers me the possibility to check its performance at all times.



...we listen

The new green&clean Glasswashers and Undercounter Dishwashers are modern solutions designed for Bars, Pubs, Cafès, small restaurants and QSR's. They are dedicated to customers that highly consider design and savings without compromising performance.



Green

Less water, energy, detergent and rinse aid consumption for lower running costs and less impact on environment



Clean

Optimal washing and rinsing performance with total detergent removal.



Safe

Guaranteed sanitation. Unique Wash-Safe Control device for a constant nominal rinsing temperature of 84 °C.



Easy

Ergonomic. Easy to operate and maintain with total control of performance at all times.



green&clean Glasswashers

Fast, compact and easy to use.

Absolute satisfaction for you and your guests.



With the environment in mind

Low consumptions in energy, water, detergent and rinse aid. **Less heat emission** thanks to the fully insulated double skin construction*.



Excellent washing and rinsing performance

Thanks to double upper and lower washing and rinsing arms. **Keep business moving** with the cold rinse feature that gives you **ready to use glasses** immediately after washing.



Guaranteed sanitation

Perfectly hygienic results with **Wash-Safe Control** guaranteeing a constant **84 °C** rinse temperature.



Easy to use and maintain

Constant monitoring thanks to highly visible temperature display. **Safe and ergonomic** counterbalanced door for soft opening and closing. User-friendly electronic control with **self-diagnosis**.



Let us ride with you

Are you looking for the user manual or do you need other support materials?

E-Tandem*, the Electrolux Professional Digital Service will help you get immediate access to numerous tools.

Simply scan the QR code on the front of the machine and start your ride.

* On selected models

The glass does make the difference

green&clean Glasswashers will increase your profits while guaranteeing sustainability, excellent performance, hygiene and ease of use.



For you and the environment

Low consumptions in energy, water, detergent and rinse aid. **Less heat emission** thanks to the fully insulated double skin construction*.



Fast service, happy customers and more profit

Keep your service moving, no need to wait for glasses to cool down. Serve excellent beer fast, in cool and sanitized glasses, thanks to the extra cold rinse program*.



Excellent washing and rinsing performance

Powerful washing pressure and perfect results thanks to double upper and lower washing* and rinsing arms.

Highest durability and longer life. Robust construction with heavy-duty stainless steel components.



Sanitation assured



No more worries! Sanitation and cleanliness go hand in hand with green&clean's Wash-Safe Control.



84 °C

constant rinse temperature.
Excellent hygienic conditions.



Guaranteed sanitation

Sanitation and rinse quality are guaranteed with green&clean's **Wash-Safe Control**. The Wash-Safe Control light turns green to guarantee rinsing has been performed perfectly. It maintains a constant rinse pressure and temperature of 84 °C thanks to a hydraulic system featuring a standard air gap and rinse pump.



Excellent hygiene

Stainless steel construction with rounded corners, designed for easy cleaning and perfect hygiene.



Easier, better and faster service



Slow operations caused by complex programs and dangerous ergonomics are daily issues in many businesses. green&clean Glasswashers are the answer to your needs.

Ergonomic design, less fatigue

Time savings

Electronic control panel with temperature display* for easy monitoring of machine.
Easy opening with recessed handle.

Safe and ergonomic

Counterbalanced door for soft opening and closing.

Optimal work environment

Double skin insulated door and cabinet* ensure a more silent operation and less heat dispersion.



Quick and easy maintenance

No need to move the machine to perform maintenance thanks to the front panel access to the components.

Highly reliable detergent and rinse aid tubes with a unique **failproof** connection for **fast, easy assembly** and **maintenance**.



Big results in a small space

Less space doesn't mean less business. The Electrolux Professional XS and S single skin models offer high performance in a compact size.

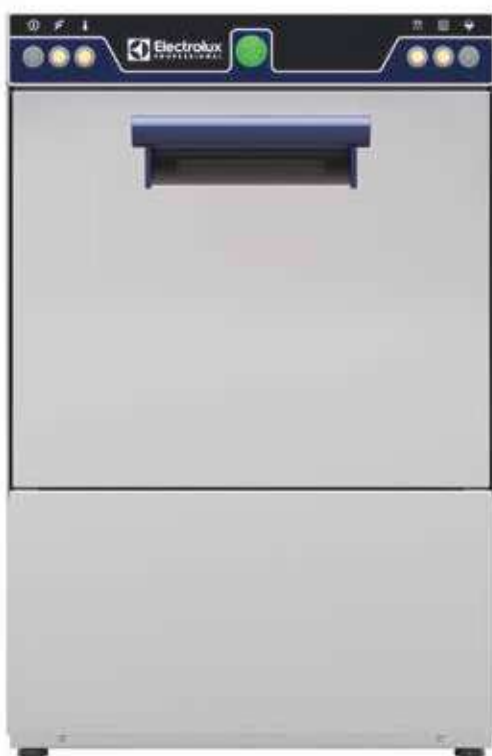

Ergonomic and high performing

Perfect washing and rinsing result thanks to the design of the powerful washing and rinsing arms.

Reliable and long lasting full stainless steel construction, wash tank and chamber. The special moulded inner cavity guarantees a **watertight solution over time** and **improved cleanability**.

Excellent ergonomics and **silent operation** thanks to double skin insulated counterbalanced door with recessed handle.

Intuitive and **easy to use** with single button operation.

Different customers, different needs

Maximum flexibility thanks to the wide range and multiple basket solutions.

XS models accept round or square baskets from 350mm up to 380mm.

S models are suitable for 400x400mm baskets, both round and square.

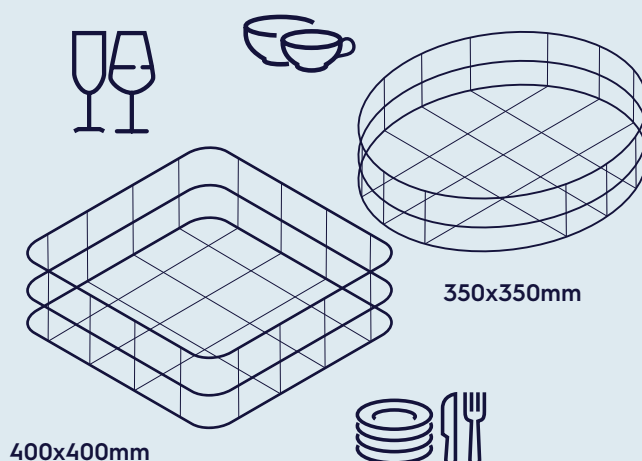



888



NEOPURE
STATO



Electrolux
PROFESSIONAL

green&clean Undercounter Dishwashers

Green, clean, safe and easy.

The ideal solution for high performance and low running costs.



Less consumptions, more savings

Consume only **2,5 liters/cycle** and **save € 730** per year*.



Excellent washing and rinsing performance

Total detergent removal and **maximum performance** thanks to double upper and lower washing and rinsing arms.



Sanitation means safety

Superior hygiene and **optimal rinsing** results with **Wash-Safe Control** that guarantees a constant 84 °C rinse temperature.



Easy and ergonomic

Safe and ergonomic counterbalanced door for soft opening and closing with **easy to grip** handle. **Self-diagnosis and constant monitoring** thanks to user-friendly electronic control with highly visible temperature display.



E-Tandem

Let us ride with you

Are you looking for the user manual or do you need other support materials?

E-Tandem**, the Electrolux Professional Digital Service will help you get immediate access to numerous tools.

Simply scan the QR code on the front of the machine and start your ride.

* Cost savings are calculated by Electrolux Professional Lab which is accredited by Intertek. Comparison made between green&clean Undercounter Dishwasher and an equivalent conventional machine using **3.5 liters/cycle** per rinsing, 70 cycles/day, 300 annual working days, 15 °C inlet water. ** On selected models.

Savings and sustainability



Electrolux Professional offers a unique global competence in technology, design, manufacturing and service, aiming to reduce running costs with less impact on the environment.



Exceptional savings:
€ 730* per year

Enjoy the € 730* per year in your pocket thanks to the savings made in water, energy, detergent and rinse aid and still guarantee optimal performance.

green&clean

the perfect balance
between optimum
performance and low
running costs.



Low water consumption

2.5lt/cycle of fresh water are needed for rinsing regardless of water inlet conditions.



Low energy consumption

Drops by 25% since less water is used for rinsing.

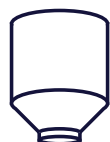

Less detergent and rinse aid consumption

Much smaller quantities are needed.

Make the best first impression



Excellent washing and rinsing performance with total detergent removal. The ideal dishwasher for cleaning plates, cups, utensils, trays, gastronomic containers and cutlery.

Clean Items guaranteed

No areas of the washing chamber remain untouched!

The powerful washing circuit guarantees **optimal washing results** regardless of where the items are placed, thanks to the unique shape of the spray nozzles and the upper and lower rotating arms.

Perfect rinsing performance

The **slanted wash arms*** and the 4-second pause after washing and before rinsing **ensures** the wash water **no longer drops** on the clean dishes after the rinse cycle.

No more damage to glassware with the "Soft Start" feature which reduces the water pressure on the items at the start of the wash cycle.



The one you can count on for optimal results

* On selected models

Safety comes first



Superior rinse quality thanks to Wash-Safe Control that guarantees a constant rinse temperature of 84 °C and water pressure independent from the mains.

84 °C

constant rinse temperature for perfect hygienic conditions.



Guaranteed sanitation

Sanitation and rinse quality are guaranteed with **green&clean's Wash-Safe Control**.

Bacteria find their ideal condition for growth in an environment with a temperature between 20 and 60° °C (max. 75 °C). Wash-Safe Control **eliminates bacteria** thanks to the constant rinse temperature of 84 °C.

The Wash-Safe Control light turns green to indicate rinsing has been performed correctly.



Simply clean. Worry-free hygiene

Avoid bacteria proliferation when the machine is not in use. The fully automatic self-cleaning cycle sanitizes the washing chamber with hot water and then completely empties the boiler.

* On selected models



Spot-free glasses and cutlery

No more residues.

Discover the importance of rinsing with soft water.



- ▶ Models equipped with Continuous Water Softener (CWS) guarantee **non-stop dishwashing** because workflow is not interrupted for resin regeneration thanks to two resin containers installed in the back: the electronic control uses one of the containers to soften the water and at the same time regenerates the resins in the other one.
- ▶ 100% of the water entering the dishwasher is softened providing **spot-free results** and **less scale build-up**.
- ▶ The water softener is integrated with the atmospheric rinse system, maintaining **high rinse water pressure** and a **constant high temperature** during the rinse phase.
- ▶ The operator can **easily load the container** without having to access the internal chamber thanks to the external salt filling cap.
- ▶ **No more worries**, a sensor advises the operator when the salt container needs to be refilled.



Designed to perform



Forget the hard work and fatigue. green&clean Undercounter Dishwashers make work operations lighter and easier to keep you smiling all day long.



New design with ergonomics in mind

Sleek and modern look to complement the design of pubs and bars.

Soft opening and closing with the lightweight counterbalanced door equipped with springs.

Quiet working environment and **less heat dispersion** thanks to the double skin insulated door and cabinet.*

Ergonomic handle for **easy operations**.

Quick and **easy maintenance** thanks to frontal access to components. **No need to move the machine**.

User friendly control panel with clear icons puts everyone at ease

Choose between **3 cycles** to wash any kind of residue.

The washing and rinsing cycle **times and temperatures can be fully customized** to meet specific customer requirements.



Wash tank filters can be **easily removed** without having to remove the washing and rinsing arms.

Reliability in first place

Durability, reliability and long life. green&clean Undercounter Dishwashers give you more than what you expect from a dishwasher.



Round corners

Wash tank with rounded corners to avoid dirt traps.



Easily removable wash/rinse arms

Wash and rinse arms are easily removable for cleaning.



IPX4 water protection

All models are certified IPX4 for water protection.



Boiler resistant to chlorinated water

The boiler, being made of A304L, is resistant to chlorinated water and is welded in an inert atmosphere to avoid contamination during the production process.



Highly durable water hose

The water supply hose has metal connections to withstand high water pressure and accidental shocks during installation.



Failproof chemical tube connection

Highly resistant and long lasting detergent and rinse aid tubes with a unique failproof connection for fast, easy assembly and maintenance.

Furthermore...

- ▶ All components in contact with water and chemicals are made of A304 stainless steel guaranteeing long-lasting operation.
- ▶ A very low noise level assures the best working environment.
- ▶ The cold rinse feature assures cold glasses immediately after washing. Push the button and the machine will first rinse with hot water (from 80-90 °C), to guarantee a perfect hygiene, then fresh cold water is used in the final rinse, delivering ready to use glasses.



Café-line: the best for your business

Café-line is the Electrolux Professional tailored solution for pubs and coffee shops where a quick and dynamic service is required while maintaining the highest hygiene results.

Keep your service moving. Wash more than 1000 cups/hour

Café-line Dishwashers are equipped with **high powered 9 kW boilers** which guarantee a **constant high rinse temperature of 84 °C** throughout the rinsing cycle regardless of the network's water pressure and temperature. **Even cold water can be used!**

Keep customers and workers happy thanks to the double skin insulated door and cabinet which ensures a low noise level and less heat dispersion.



Café-line Undercounter Dishwasher is positioned **on wheels** to facilitate cleaning both behind and underneath the machine.

The **automatic loading** of **rinse aid** and **detergent** from first to last cycle guarantees **perfect results** while **minimizing service** and maintenance. Detergent and rinse aid dispensers are included.



Wine-line: because we care about your crystals

Shiny glasses are the best presentation for restaurants and wine bars.

Electrolux Professional, together with the main detergent producer and leaders in water treatment systems, has developed a full solution for best glass washing and spot free drying results.



The gentle solution for your crystal glasses

The Wine-line Undercounter is able to **significantly reduce damage** normally caused to crystal and glass surfaces and **no manual polishing** is needed thanks to:

- ▶ the lower washing temperature of **50-55 °C**
- ▶ the atmospheric boiler that guarantees sanitation with a **constant 84 °C rinsing temperature** and **pressure** to eliminate any detergent residue
- ▶ the soft start wash pump
- ▶ the complete offer including: reverse osmosis water treatment, dedicated detergent and rinse aid solution and basket and trolley accessories.

Optimal washing conditions have been defined together with "Stazione Sperimentale del Vetro" (a leading Italian Glass Research Institution) and the main European crystal producers.



Wine-line basket design

The Wine-line basket has been designed to improve washing results, reduce drying time and ease glass handling.

- ▶ **Glass rim is kept far from the basket base** allowing more accurate washing and rinsing of the internal surface.
- ▶ **Hung and tilted glass position** secures the drying phase and reduces glass breakage.
- ▶ Designed to **fit all types of long stem glasses** up to 270mm long and 104mm wide.



Pastry, bakery & pizza

Hand washing large items is now a thing of the past. Electrolux Professional has the perfect solution for less hard work and more free time.



A compact, high performing solution for washing large items

Optimal washing and rinsing performance thanks to the stainless steel upper and lower washing and rinsing arms.

High quality rinsing with the atmospheric boiler that guarantees a large quantity of hot water at a constant high temperature.

Workers and customers will thank you for the **low noise level** and **cool environment** thanks to the double skin door and cabinet.

Perfect results and **less maintenance** with the built-in detergent and rinse aid dispensers.

Choose from 4 different **wash cycles** based on your needs and wash up to 40 baskets per hour.

Baking trays, bread baskets, wares and more

Extremely versatile, able to wash 600x400mm baking trays and even large bread baskets thanks to the 41cm high opening, in addition to accepting different basket sizes (600x500mm and 500x500mm).





hygiene&clean

More than just clean.

Disinfected

FIRST
in the industry

The hygiene&clean Undercounter Dishwasher doesn't just sanitize, it disinfects.*

The hygiene&clean Undercounter complies with DIN 10512 standard and performs at the disinfection level **A₀ of 60** as defined by the UNI EN ISO 15883-1 that normally only applies to medical equipment



DIN 10512

Rinsing temp.

90 °C

Rinsing time

12 sec



A₀ 60

Rinsing temp.

90 °C

Rinsing time

16 sec

- ▶ **Disinfection guaranteed!** Bacteria reduction achieved thanks to the mix between cycle length, washing and rinsing temperatures and chemical action. Door lock mechanism ensures cycle is not interrupted.
- ▶ **Safety first!** Visualize the safety temperature from remote thanks to the 24/7 monitoring.
- ▶ Rinse water consumption: 3 liters/cycle (DIN 10512 compliant); 4 liters/cycle (A₀ 60 compliant).



**99,999% reduction
of bacterial load**

The hygiene&clean Undercounter Dishwasher reduces the risk of exposure to dangerous pathogens, making sure customers and workers stay safe at your business.



* Disinfection is defined as "Thermal or chemical destruction of pathogenic and other types of microorganisms" in the Glossary Guideline for Disinfection and Sterilization in Healthcare Facilities by the Centers for Disease Control and Prevention (CDC). See more at <https://www.cdc.gov/infectioncontrol/guidelines/disinfection/glossary.html>
The A₀ of 60 is achieved assuming that machines are used and maintained as per manufacturer's specifications.

Don't compromise performance

To get the **best washing results**, you need to choose not only the **right machine** and a **matching water treatment system**, but also a **specific detergent and rinse aid**. Using inappropriate detergent and/or rinse aid, not only compromises a perfect washing result but also increases the risk of damaging glasses in a shorter time.



C11 Detergent for dishwashers

For all water types with best performance indicated for glass, crystal, ceramic, porcelain, plastic and stainless steel.



C12 Rinse Aid for dishwashers

Perfect drying results guaranteed, without manual actions. For all types of water hardness. Indicated for glass, crystal, ceramic and porcelain.



ECO friendly

C13 ECO Detergent for dishwashers

Eco friendly chemical with low environmental impact. Concentrated formula without EDTA, NTA and polyphosphates.



ECO friendly

C14 Rinse Aid Plus for dishwashers

For all types of water hardness. Indicated for glass, crystal, ceramic and porcelain.

Don't forget to choose the best treatment for your water

Water softening

Transforms calcium and magnesium ions into non-hardening sodium ions/soluble salts. Rinse aid and detergents achieve good cleaning results with low consumption.

Partial demineralization

Improves the cleanliness of wares, removing all calcium and magnesium mineral content of the water, with deposit-free wash results.





















Total demineralization

Completely removes salts and minerals from the water, resulting in distilled water to produce a dazzling shine without the need for further polishing.

Reverse osmosis

Uses filtration through membranes that capture all the salt and some types of bacteria. No deposits are left on wares which come out of the dishwasher spotlessly clean and sparkling.

The right solution

1	2	3	4	5	
What are you going to wash?	Water hardness (°F) *	Recommended water treatment	Water hardness after treatment (°F) *	Detergent to be used	
 Glasses and crystals	Soft 0 ÷ 7	None	Soft 0 ÷ 7	 	
	Medium Soft 7 ÷ 15	For crystals use total or partial demineralization		Medium to Hard 7 ÷ 25	C13 Eco Detergent for Dishwashers C14 Rinse Aid Plus for Dishwashers
	Medium Hard 15 ÷ 25	For crystals use total or partial demineralization while for standard glasses use water softener			 
	Hard / Very Hard 25 ÷ 45	For standard glasses use water softener while for crystals use water softener plus reverse osmosis			C11 Detergent for Dishwashers C12 Rinse Aid for Dishwashers
 Cups and mugs	Soft 0 ÷ 7	None	Soft 0 ÷ 7	 	
	Medium Soft 7 ÷ 15	Total or partial demineralization		Medium to Hard 7 ÷ 25	C13 Eco Detergent for Dishwashers C14 Rinse Aid Plus for Dishwashers
	Medium Hard 15 ÷ 25				 
	Hard / Very Hard 25 ÷ 45				Water softener
 Plates and cutlery	Soft 0 ÷ 7	None	Soft 0 ÷ 7	 	
	Medium Soft 7 ÷ 15	Water softener		Medium to Hard 7 ÷ 25	C13 Eco Detergent for Dishwashers C14 Rinse Aid Plus for Dishwashers
	Medium Hard 15 ÷ 25				 
	Hard / Very Hard 25 ÷ 45				Water softener
 Stainless Steel Pots	Soft 0 ÷ 7	None	Soft 0 ÷ 7	 	
	Medium Soft 7 ÷ 15	Water softener		Medium to Hard 7 ÷ 25	C13 Eco Detergent for Dishwashers C14 Rinse Aid Plus for Dishwashers
	Medium Hard 15 ÷ 25				 
	Hard / Very Hard 25 ÷ 45				Water softener

* Water hardness to be measured with 0W7PJK test strips or OS1701 for expert technicians only

Range

green&clean Glasswashers



DESCRIPTION	XS Single skin	S Single skin
Electronic control		
Electro-mechanical control	•	•
Wash-Safe Control		
Cold rinse		o
No. of cycles	1	1
Maximum capacity (baskets/hour)	30	30
Door clearance (mm)	250	300
External dimensions (WxDxH) - mm	440x497x640	455x550x700
Basket dimension (mm)	from 350x350 (Ø350) - up to 380x380 (Ø380)	400x400 (Ø400)
Installed power (kW)	2,89	2,89
Water consumption (lt/cycle)	2 (hot rinse)	2 (hot rinse)
Built-in rinse aid dispenser	•	•
Electrical connection	230V/ 1N/ 50Hz	230V/ 1N/ 50Hz
Included accessories	1 basket 380x380mm + 1 insert for 12 saucers + 1 cutlery container	1 basket 400x400mm + 1 insert for 12 saucers + 1 cutlery container



green&clean Undercounter

DESCRIPTION	EL Single skin	ELA Single skin
Wash-Safe Control		•
Double skin insulated walls		
No. of cycles	2	2
Maximum capacity per hour	30 baskets / 540 dishes	30 baskets / 540 dishes
Door clearance (mm)	330	330
External dimensions (WxDxH) - mm	600x648x820	600x648x820
Basket dimension (mm)	500x500	500x500
Installed power (kW)	5,35	5,35
Water consumption (lt/cycle)	3	3
Built-in rinse aid dispenser	•	•
Built-in drain pump & detergent dispenser	o	o
Electrical connection	400V/3N/50Hz, convertible on site to 230V/1N or 230V/3/50Hz	400V/3N/50Hz, convertible on site to 230V/1N or 230V/3/50Hz
Included baskets	1 basket for 18 plates + 1 cutlery container	1 basket for 18 plates + 1 cutlery container



S Double skin	Short S Double skin	S Double skin	S Double skin
•	•	•	•
•			•
	•	•	•
1	3	3	3
30	30	30	30
290	210	290	290
460x565x715	460x565x635	460x565x715	460x565x715
400x400 (Ø400)	400x400 (Ø400)	400x400 (Ø400)	400x400 (Ø400)
3,3	3,3	3,3	3,3
2.3 (hot rinse)	2.3 (hot rinse)/ 1.8 (cold rinse)	2.3 (hot rinse)/ 1.8 (cold rinse)	2.3 (hot rinse)/ 1.8 (cold rinse)
•	•	•	•
230V/ 1N/ 50Hz	230V/ 1N/ 50Hz	230V/ 1N/ 50Hz	230V/ 1N/ 50Hz
1 basket 400x400mm	1 basket 400x400mm + 1 cutlery container	1 basket 400x400mm	1 basket 400x400mm



ELI Double skin	ELAI Double skin	Wine-line	Café-line	Pastry, bakery & pizza	hygiene&clean
•	•			•	•
•	•	•	•	•	•
3	3	3	3	4	3
40 baskets / 720 dishes	40 baskets / 720 dishes	40 baskets / 720 dishes	40 baskets / 720 dishes	40 baskets / 880 dishes	40 baskets / 480 dishes (DIN 10512)
335	335	335	335	400	335
600x615x820	600x615x820	600x615x820	600x615x820	600x703x850	600x615x820
500x500	500x500	500x500	500x500	600x500; 500x500	500x500
5,35	5,35	6,85	9,85	6,68	6,85
2.5	2.5	3.8	2.5	2	3.0 (DIN 10512) 4.0 (A ₀ 60)
•	•	•	•	•	•
	o	•	•	•	•
400V/3N/50Hz, convertible on site to 230V/1N or 230V/3/50Hz	400V/3N/50Hz, convertible on site to 230V/1N or 230V/3/50Hz	400V/3N/50Hz, convertible on site to 230V/1N or 230V/3/50Hz	400V/3N/50Hz, convertible on site to 230V/1N or 230V/3/50Hz	400V/3N/50Hz, convertible on site to 230V/1N or 230V/3/50Hz	400V/3N/50Hz, convertible on site to 230V/1N or 230V/3/50Hz
1 basket for 18 plates + 1 basket for cups + 2 cutlery containers	1 basket for 18 plates + 1 basket for cups + 2 cutlery containers	1 basket for cups + 1 basket for wine glasses	1 basket for 18 plates + 1 basket for cups + 2 cutlery containers	1 basket 600x500mm for plates + 1 s/s rack for 600x400mm trays	1 basket for 12 dishes + 1 basket for cups + 2 cutlery containers

Dedicated accessories

Improve operations and performance. Choose from a wide range of warewashing accessories for better efficiency in the workplace.



Basket for 18 dinner plates



Basket for 12 soup bowls

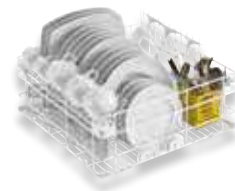

Multi-purpose basket
500x500x190 mm



Basket for 48 small cups



Wine-line basket



Stand for Undercounter
Dishwasher



12 lt external manual
water softener



8 lt external automatic
water softener



Full range of sinks units
available

For additional baskets and other accessories consult our price list



OnE Connected, your digital assistant

Connected
green&clean
Undercounter
Dishwashers*



OnE Connected helps you get top performances from your Electrolux Professional solutions. This will maximize your profits and accelerate your return on investment.



Improve your work life

Zoom into the current status of each green&clean Dishwasher from anywhere at anytime to check washing and rinsing temperatures and at which speed the machine is being used.

Smart usage. Use OnE Connected to know when your green&clean is on, undersized or oversized so that you can balance the process.



Earn more

Electrolux Professional OnE Connected helps you reduce consumptions to a minimum and optimize the efficiency of your business.

Smart upgrade of your machine. Monitoring productivity, you discover you need a more productive dishwasher to improve the process. Upgrade as you go along, green&clean dishwashers grow with your business.

Smart configuration. Now you have all the info you need to order your next dishwasher with the right capacity for your business.

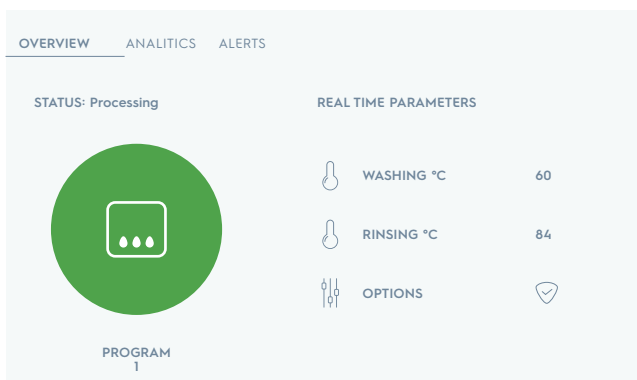

**OnE Connected
monitors your work and
helps you to create the
right solution for your
dishwashing area**

Digital platform

OnE Connected



Customer Care



giving you



Boost your performance

Remote speed diagnosis from anywhere: product code, serial number and any error codes to increase accuracy.

OnE Connected helps ensure maximum uptime while reducing any inconvenience for unexpected breakdowns.

For additional benefits subscribe to Essentia Service Agreement



Maximize uptime of your equipment

OnE Connected gives you the insight to **better organize your work flow.**

Monitor the status of your green&clean dishwashers, also in multiple locations using direct comparison charts in a single snapshot Track actual processing time, operator waiting time and total working time (whether hourly, daily, monthly or yearly).

The outcome will help you to organize your staff and optimize your work flow avoiding dead times.

STATUS: Blocked



ALERT DETAILS

LAST ACTIVITY
 User date: 11/05/2019 02:45 PM
 Site date: 11/05/2019 02:45 PM

PNC / SN
 9CGX502026 37-92310012

TICKET ID
 171150

ANOMALY
 C12

DESCRIPTION
 Tank level sensor out of order

TROUBLE SHOOTING
 Clean the tank and remove any visible cloggin from the air trap. Switch OFF/ON and if the problem persists call service.



Organize your staff, maximize your time. OnE Connected tracks every aspect to optimize your workflow



Service agreements, you can trust

You can choose from **flexible tailored-made service packages**, according to your business needs, offering a variety of maintenance and support services.



Essentia Teamed to serve you. Anytime, anywhere

Essentia is **the heart of superior Customer Care**, a dedicated service that ensures your competitive advantage. Essentia provides you with the support you need and takes care of your processes with a **reliable service network**, a range of tailor-made exclusive services and innovative technology.

You can count on more than **2,200 authorized service partners**, **10,000 service engineers** in more than **149 countries**, and over **170,000 managed spare parts**.

Service network, always available

We stand ready and committed to support you with a **unique service network** that makes **your work-life easier**.

Keep your equipment performing

Undertaking correct maintenance in **accordance with Electrolux Professional Manuals** and recommendations is essential to avoid unexpected issues. **Electrolux Professional Customer Care** offers a number of **tailor made service packages**. For more information contact your preferred Electrolux Professional **Authorized Service Partner**.

You can rely on the quick dispatch of original Accessories & Consumables, rigorously tested by Electrolux Professional experts to ensure **durability and performance of your equipment**, together with **user safety**.



**Watch
the video**
and find out more



Excellence is central to everything we do.
By anticipating our customers' needs, we strive for
Excellence with our people, innovations, solutions and services.
To be the OnE making our customers' work-life easier,
more profitable – and truly sustainable every day.

Follow us on



www.electroluxprofessional.com

Excellence with the environment in mind

- ▶ All our factories are ISO 14001-certified
- ▶ All our solutions are designed for low consumption of water, energy, detergents and harmful emissions
- ▶ In recent years over 70% of our product features have been updated with the environmental needs of our customers in mind
- ▶ Our technology is RoHS and REACH compliant and over 95% recyclable
- ▶ Our products are 100% quality tested by experts

